

Data Sheet



Article number: 339702160000

Description: Multibeam 6 Coupling 702.16.0000
St. steel & set screw hubs

Measures

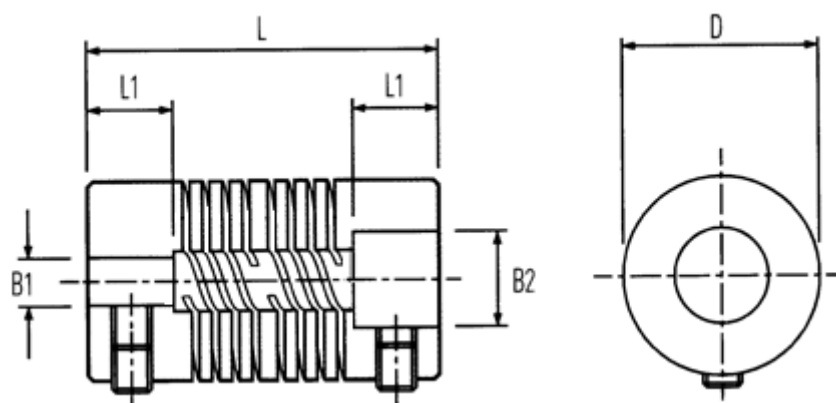

B1: Pre-drilled	= 3.0	Peak Torque NM = 5.00
B2: Pre-drilled	= 6.00	Set Screw = M4
D	= 15.9	
L	= 25.4	
L1	= 6.5	
Max angular displacement	= 0.20	
Max B1 & B2	= 8.00	
Max parallel displacement	= 5	